

## Officina Table

Design Ronan & Erwan Bouroullec, 2015

### Table Ø100 cm.

Frame in wrought iron, galvanized or cathodically treated and painted in polyester powder. Top in steel sheet electro-galvanized and painted polyester powder, in Carrara marble white or in solid American walnut.

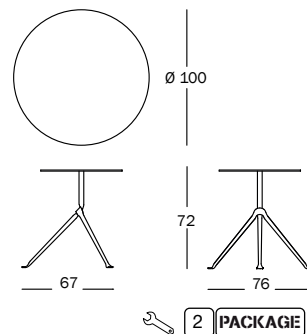

| Art. nr.      | Frame in wrought iron | Top                  |  |
|---------------|-----------------------|----------------------|--|
| TV2220 TV2225 | galvanized 5250       | steel sheet black    |  |
| TV2220 TV2233 | galvanized 5250       | Carrara marble white |  |
| TV2221 TV2225 | grey anthracite 5142  | steel sheet black    |  |
| TV2221 TV2227 | grey anthracite 5142  | American walnut      |  |
| TV2221 TV2233 | grey anthracite 5142  | Carrara marble white |  |

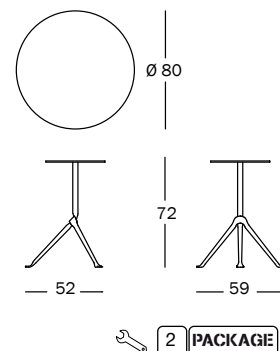

### Table Ø80 cm.

Frame in wrought iron, galvanized or cathodically treated and painted in polyester powder. Top in steel sheet electro-galvanized and painted polyester powder, in Carrara marble white or in solid American walnut.





| Art. nr.      | Frame in wrought iron | Top                  |  |
|---------------|-----------------------|----------------------|--|
| TV2240 TV2245 | galvanized 5250       | steel sheet black    |  |
| TV2240 TV2253 | galvanized 5250       | Carrara marble white |  |
| TV2241 TV2245 | grey anthracite 5142  | steel sheet black    |  |
| TV2241 TV2247 | grey anthracite 5142  | American walnut      |  |
| TV2241 TV2253 | grey anthracite 5142  | Carrara marble white |  |

#### Frame in wrought iron

-  galvanized 5250
-  grey anthracite 5142

#### Top

-  Carrara marble white
-  American walnut
-  steel sheet black

#### Top thickness

- Carrara marble: 20 mm
- American walnut: 25 mm
- steel sheet: 17 mm

## Officina Table



Design Ronan & Erwan Bouroullec, 2015

Table Ø 55 cm.

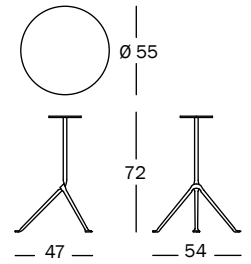

Frame in wrought iron, galvanized or cataphoretically treated and painted in polyester powder. Top in Carrara marble white or in solid American walnut.





 2 **PACKAGE**

| Art. nr.      | Frame in wrought iron | Top                  |   |
|---------------|-----------------------|----------------------|---|
| TV2260 TV2273 | galvanized 5250       | Carrara marble white |  |
| TV2261 TV2267 | grey anthracite 5142  | American walnut      |   |
| TV2261 TV2273 | grey anthracite 5142  | Carrara marble white |  |

### Frame in wrought iron

-  galvanized 5250
-  grey anthracite 5142

### Top

-  Carrara marble white
-  American walnut

### Top thickness

- Carrara marble: 20 mm
- American walnut: 25 mm