

MAGIS

Officina - Living



by Ronan & Erwan Bouroullec

Ronan & Erwan Bouroullec



Profile:

Ronan Bouroullec (born in 1971) and Erwan Bouroullec (born in 1976) have been working together for more than twenty years now. Their collaboration is a permanent dialogue, nourished by their distinct personalities and a shared notion of diligence, with the intention to achieve greater balance and refinement.

In 1997, they presented their Disintegrated Kitchen at the Salon du Meuble in Paris, where it was spotted by Giulio Cappellini, who gave them their first industrial design commissions. The Bouroullecs have been working with Magis since 2004, designing three complete furniture collections – Striped, Steelwood and Officina – as well as additional projects such as Pila chair, Pilo table, Central and Tambour tables. These days, Ronan and Erwan Bouroullec design for numerous manufacturers, including Magis, Vitra, Kvadrat, Kartell, Established and Sons, Ligne Roset, Axor, Alessi, Issey Miyake, Cappellini, Mattiazzi, Flos, Mutina,

Hay and more recently Glas Italia and Iittala. They also continue to carry out their own experimental activity which is essential to the development of their work at Galerie kreò, Paris, where four exhibitions of their designs were held between 2001 and 2012. They also embark on occasional architectural projects.

Voted Designers of the Year at the Salon du Meuble in 2002, their other awards include the Compasso d'Oro won in 2011 for the Steelwood chair they designed for Magis.

Several exhibitions have been devoted to their work.

In 2012, Phaidon Press published *Works*, a comprehensive monographic book about Ronan and Erwan Bouroullec. Previously, two other monographs had been published about the Bouroullec brothers' design work: *Ronan et Erwan Bouroullec – Catalogue de Raison* (Paris: Images Modernes / kreò, 2002) and *Ronan et Erwan Bouroullec* (Paris: Phaidon Press, 2003).



Design and

Forging, the process used to shape iron, pressing it between the hammer and anvil, has a history that stretches back over millennia. Throughout the ages, this technique has been used to create an infinite number of everyday objects and decorative artefacts. The Officina collection explores the possibility of establishing a new creative language while working with an ancient fabrication process such as iron forging. The collection includes tables and low tables, chairs, low chairs, stools, benches, a series of accessories (from coat stands to a valet stand to candelabras and mirror) and upholstered pieces (two armchairs, an ottoman and two-and three seater sofas). All these pieces feature a forged iron structure with the allure of a raw material handed down through the centuries, alive, with those slight imperfections that make each piece in this collection unique, with an unmistakably industrial feel, but combined with a profoundly refined and elegant spirit.

Ronan & Erwan Bouroullec

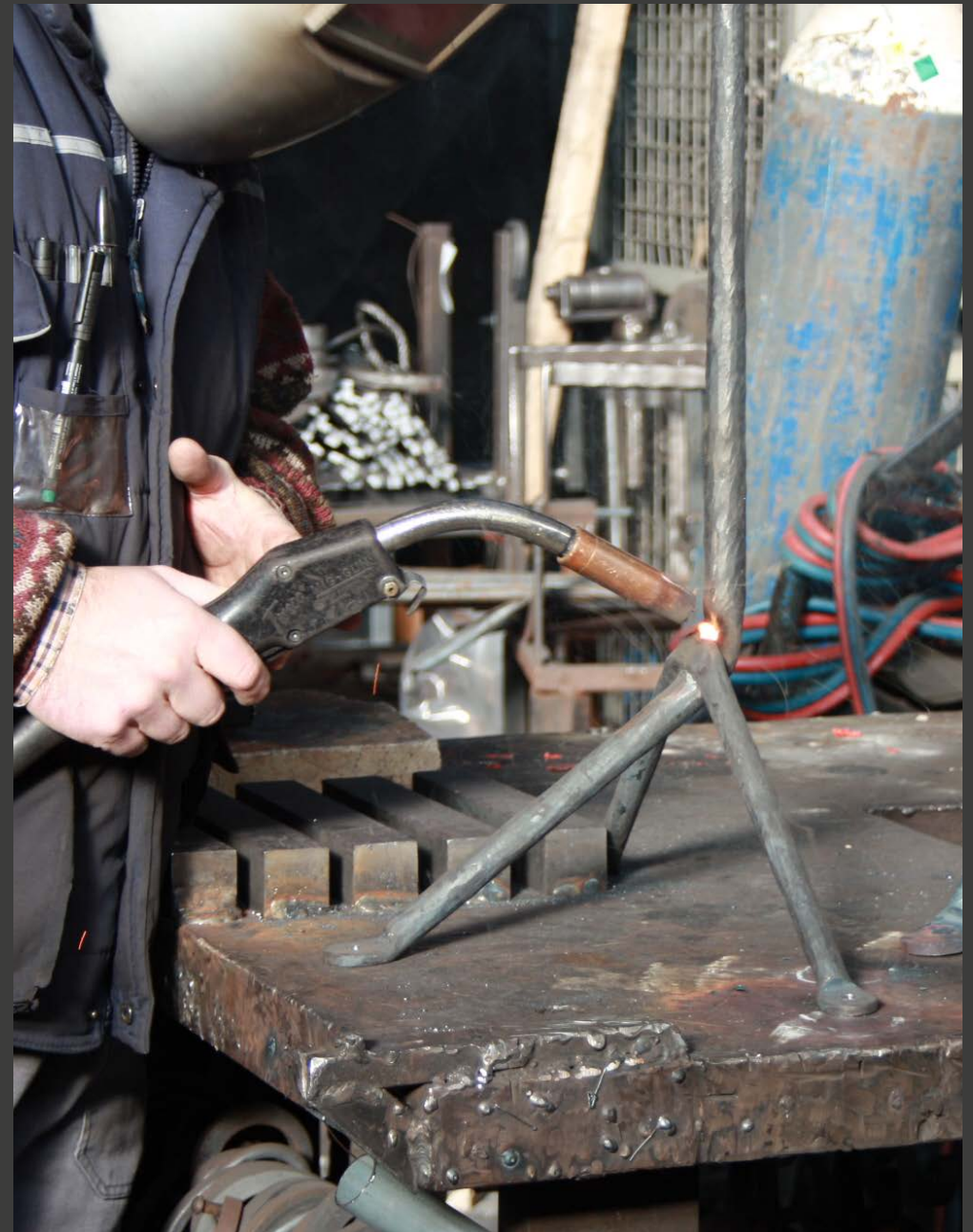

Engineering



“ The essence of wrought iron is imperfect, li-



vely and close to drawing techniques ”



A modern, high-back armchair upholstered in a textured green fabric. It features a black metal frame with four legs and a matching green ottoman. The chair is positioned in a living room with a wooden floor and a window in the background.

A small, round, black metal side table with a tripod base. It holds a green ceramic vase with a plant, a white mug, and a small book. The table is positioned next to the green chair.

A wooden shelving unit with multiple open shelves. It holds various decorative items, including green vases, a bowl, and books. The unit is positioned against a white wall.

A stack of books on the floor. Visible titles include "VIAGGI NELLA NATURA", "WALTER BONATTI", "BICI", and "TOM ROBBINS".

A stack of magazines on a shelf. Visible titles include "self service" and "ITALIAN TOUCH".

Information



Product

LOW CHAIR

- Seat and back in beech plywood, frame in wrought iron, galvanized or painted in polyester powder. Complete with felt pads. Seat cushion available.
- Seat and back covered, frame in wrought iron, galvanized or painted in polyester powder. Seat and back covered in fabric (Kvadrat "Divina MD" and "Divina Melange") or in premium-grade leather. Complete with felt pads. Seat cushion available.

BENCH W/ BACK

- Seat and back in beech plywood, frame in wrought iron, galvanized or painted in polyester powder. Complete with felt pads.
- Seat and back covered, frame in wrought iron, galvanized or painted in polyester powder. Seat and back covered in fabric (Kvadrat "Divina MD" and "Divina Melange"). Complete with felt pads.

BENCH

- Seat in beech plywood, frame in wrought iron, galvanized or painted polyester powder.
- Seat in steel electro-galvanized and painted polyester powder, frame in wrought iron, cathodically treated and painted in polyester powder.

ARMCHAIR / HIGH BACK / SOFA

Frame in wrought iron, galvanized or painted in polyester powder. Cushion in expanded polyurethane fireproof (class 1IM) covered in leather or with removable cover in fabric. Lumbar cushion available.

OTTOMAN

Frame in wrought iron, galvanized or painted in polyester powder. Cushion in expanded polyurethane fireproof (class 1IM) covered in leather or with removable cover in fabric.

LOW TABLE

Frame in wrought iron, galvanized or cathodically treated and painted in polyester powder. Top in Carrara marble white or in solid American walnut.

BOOKCASE SYSTEM

Uprights in wrought iron painted in polyester powder. Shelves in MDF walnut veneered or painted black.



LOW CHAIR

w/ seat and back in beech plywood



Frame in wrought iron /
Galvanized 5250
Grey anthracite 5142

Seat and back /
Colours
Colours

w/ seat and back covered



Frame in wrought iron /
Galvanized 5250
Grey anthracite 5142

Seat and back /
Leather
Leather
Fabric
Fabric

BENCH

w/ seat and back in beech plywood



Frame in wrought iron /
Galvanized 5250
Grey anthracite 5142

Seat and back /
Colours
Colours

w/ seat and back covered



Frame in wrought iron /
Galvanized 5250
Grey anthracite 5142

Seat and back /
Fabric
Fabric

Materials /

Frame in wrought iron /



Galvanized 5250
Grey anthracite 5142

Beech plywood /



Natural 7011
Black 7140

Fabric /



Kvadrat Divina Melange 120 / light grey
Kvadrat Divina MD 193 / dark grey

Leather /



Natural L-0090
Black L-0059

w/ seat and back in beech plywood

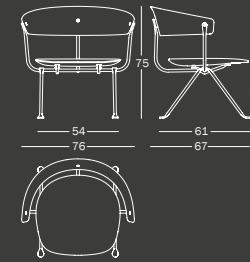

w/ seat and back covered

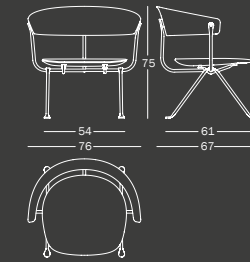

cushion

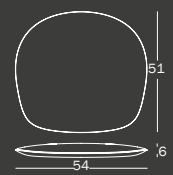

w/ seat and back in beech plywood

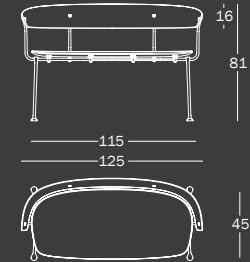

w/ seat and back covered

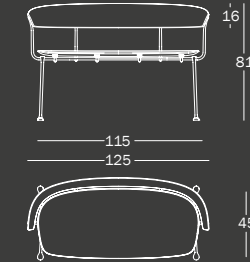

PRODUCT CARE

FABRIC /

Daily care and immediate stain removal will ensure that your wool upholstery will keep looking good for many years to come. It is normally sufficient to regularly vacuum and air upholstered product. Never use undiluted cleaning agents, bleaching agents, ammonia or soap intended for hard surfaces. As a general rule, many types of stain can be removed using warm water. For greasy stains, use a dry stain remover. For more insoluble stains (chewing gum, candle wax, etc.), use a plastic bag filled with ice to rub the stain until the substance has become friable. Use a clean flat blunt blade to delicately remove the substance. Be careful when using solvents, because these could dissolve the upholstery material beneath.

Divina Melange/ Divina MD (Kvadrat)



LEATHER /

Regularly clean using a dry and soft rag. When needed, use products especially formulated for leather. Immediately dry after the treatment. Do not use abrasive sponges as they may leave scratches. Where there was a stain of ink or similar, use only the specific stick that is commonly available on the market. Avoid direct exposure to sunlight or heat sources.

WOOD /

When needed, use ph-balanced liquid soap especially formulated for wood, diluted in water. Do not use abrasive sponges, as they may leave scratches. Avoid using acidic products, solvents and products containing ammonia. Avoid exposure to sunlight as this may permanently discolour the surface.

WARNING

Do not use different cleaning products from the ones mentioned above. Do not use the product in an improper way. Do not place hot objects on it, sit down on the back, stand on the seat or use the product as a ladder. Once disused, please make sure this product is disposed in an environment-friendly way. For the fabric version: treat stains immediately, the longer they remain in the fabric, the harder it is to remove them. Before choosing a cleaning method, always try it out on a concealed part of the product. Magis is not liable for any damage to property or persons caused

by an improper use of this product.



BENCH

w/ seat in beech plywood



Frame in wrought iron /
Galvanized 5250
Grey anthracite 5142

Seat /
Colours
Colours

w/ seat in steel



Frame in wrought iron /
Galvanized 5250
Grey anthracite 5142

Seat /
Black
Black

Materials /

Frame in wrought iron /



Galvanized
5250



Grey anthra-
cite 5142

Beech plywood /



Natural
7011



Black
7140

Seat in steel /



Black

w/ seat in beech plywood

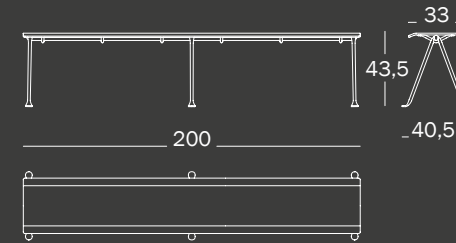
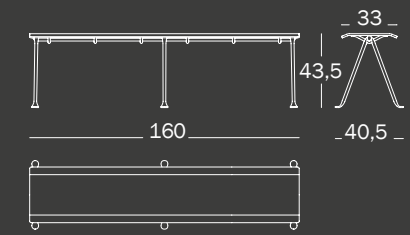
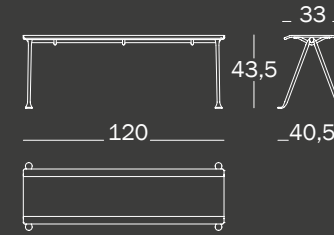

w/ seat in steel

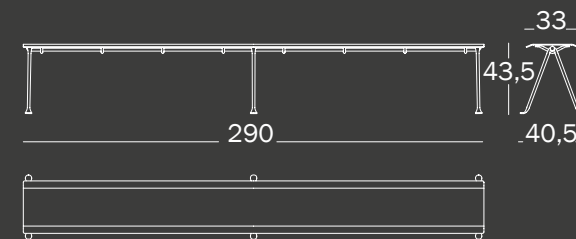
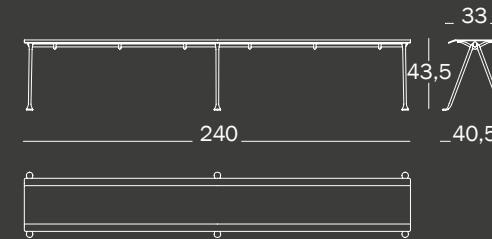

PRODUCT CARE

We recommend using a soft rag, either dry or wet. When needed, use ph-balanced soap diluted in water. Do not use abrasive sponges as they may leave scratches. Avoid using acidic products, solvents and products containing ammonia. We recommend using ph-balanced liquid soap especially formulated for wood, diluted in water. Periodic and correct maintenance allows the product to keep its original aspect and lengthens the duration of its performance.

WARNING

Do not use different cleaning products from the ones mentioned above. Do not use the product in an improper way. Do not place hot objects on it, stand on it or use the product as a ladder. Once disused, please make sure that this item is disposed of in an environmentally-friendly way.

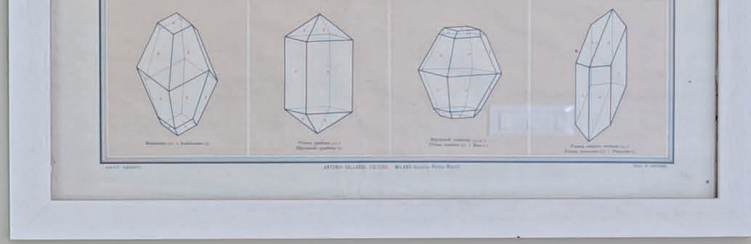

ARMCHAIR



Frame in wrought iron / Galvanized 5250	Upholstery / Fabric cat 1
Grey anthracite 5142	Fabric cat 1
Galvanized 5250	Fabric cat 2 + moodboard
Grey anthracite 5142	Fabric cat 2 + moodboard
Galvanized 5250	Leather
Grey anthracite 5142	Leather

HIGH BACK



Frame in wrought iron / Galvanized 5250	Upholstery / Fabric cat 1
Grey anthracite 5142	Fabric cat 1
Galvanized 5250	Fabric cat 2 + moodboard
Grey anthracite 5142	Fabric cat 2 + moodboard
Galvanized 5250	Leather
Grey anthracite 5142	Leather

SOFA



Frame in wrought iron / Galvanized 5250	Upholstery / Fabric cat 1
Grey anthracite 5142	Fabric cat 1
Galvanized 5250	Fabric cat 2 + moodboard
Grey anthracite 5142	Fabric cat 2 + moodboard
Galvanized 5250	Leather
Grey anthracite 5142	Leather

OTTOMAN

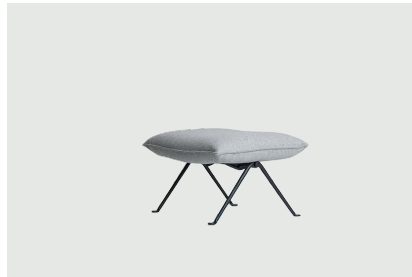

Frame in wrought iron / Galvanized 5250	Upholstery / Fabric cat 1
Grey anthracite 5142	Fabric cat 1
Galvanized 5250	Fabric cat 2 + moodboard
Grey anthracite 5142	Fabric cat 2 + moodboard
Galvanized 5250	Leather
Grey anthracite 5142	Leather

Materials /

Frame in wrought iron /

Fabric cat 1 /

Fabric cat 2 /

Fabric moodboard /

Leather /



Galvanized 5250

Grey anthracite 5142

Torri Lana Rico
Glamour Azimut

Kvadrat Divina MD
Kvadrat Divina Melange
Kvadrat Hero
Kvadrat Vidar

Moodboard A
Moodboard B
Moodboard C
Moodboard D
Moodboard E

Florida

Armchair

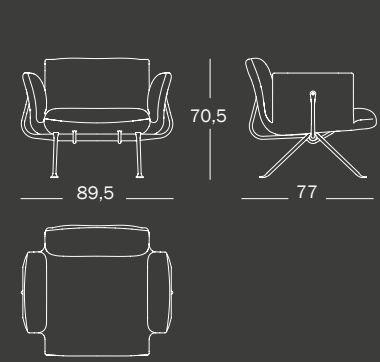

High back

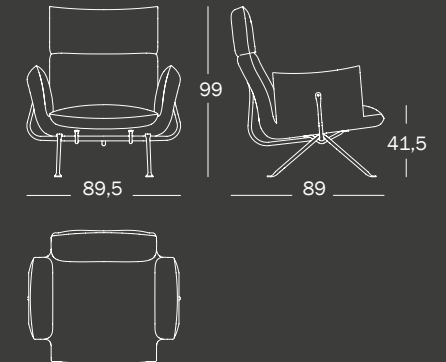

Sofa

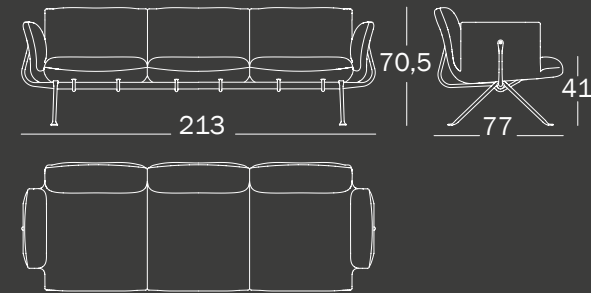
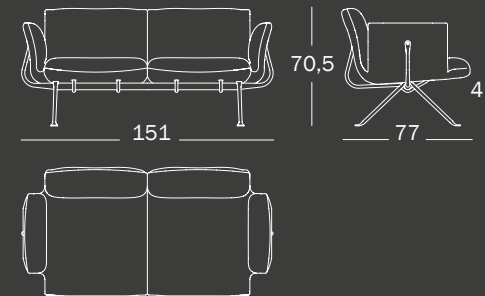

Ottoman

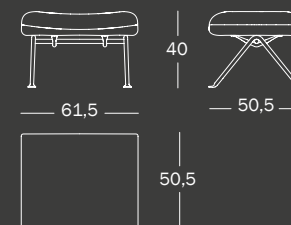

Lumbar cushion

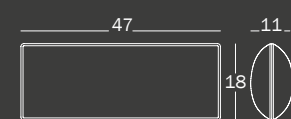

Fabric cat 1 /

Torri Lana Rico



Glamour Azimut



Fabric cat 2 /

Kvadrat Divina MD

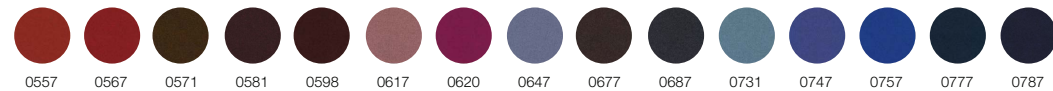
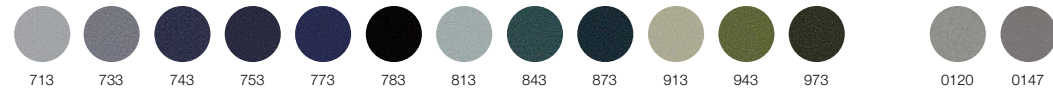
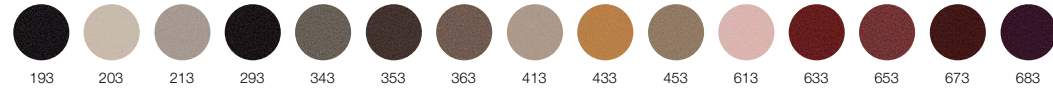

Kvadrat Hero

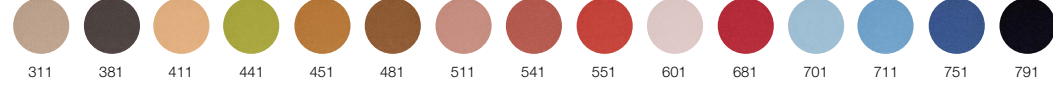
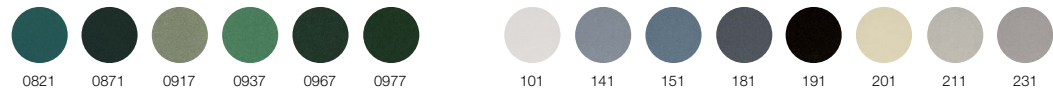

Kvadrat Vidar

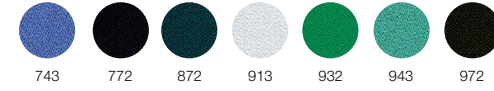
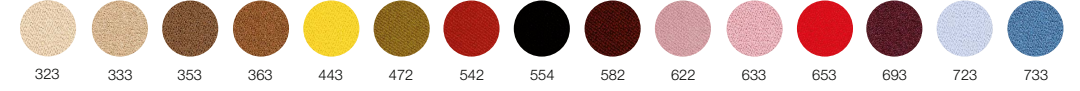
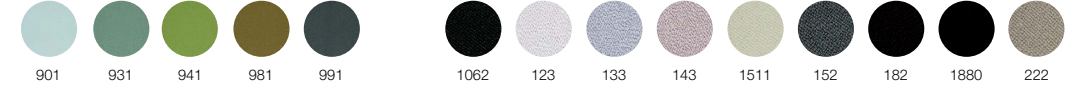

Leather /

Florida

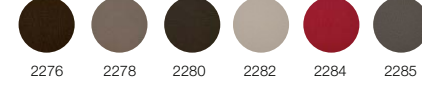
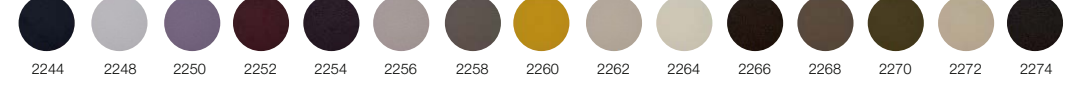
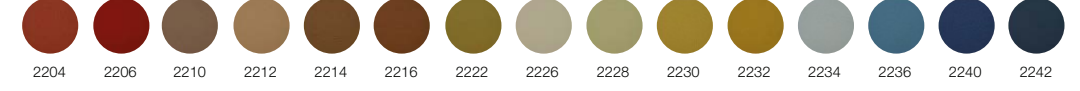
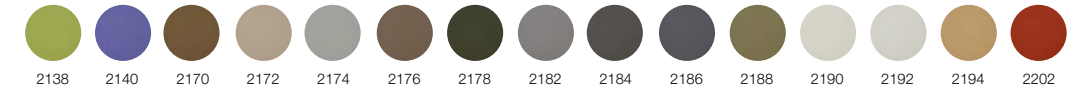
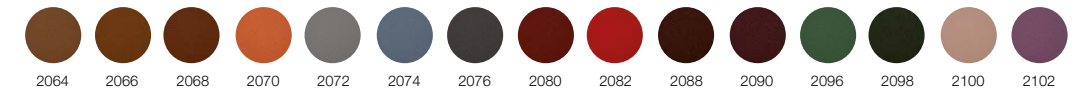

Moodboard A



- 1-Kvadrat-Mélange Nap 351
- 2-Limonta- Volpe 114
- 3-Limonta- Somme 98
- 4-Kvadrat- Recheck 455
- 5-Limonta-Sienna 107
- 6-Kvadrat- Recheck 165
- 7-Limonta- Domanico 24

- 8-Kvadrat- Hero 2 0512
- 9-Home Decor- Millerighe 404
- 10-Kvadrat-Mélange Nap 271
- 11-Kvadrat-Encircle 0662
- 12-Home Decor- Drill 404
- 13-Limonta- Persiano 204

Moodboard C



- 1-Home Decor- Enea Check 015
- 2-Kvadrat-Mélange Nap 711
- 3-Kvadrat-Encircle 0722
- 4-Limonta-Alpina 402
- 5-Limonta-Somme 104
- 6-Home Decor- Enea 015
- 7-Limonta- Indianskop 46

- 8-Limonta- Agamoto 11
- 9-Limonta- Volpe 113
- 10-Kvadrat-Recheck 845
- 11-Kvadrat-Recheck 985
- 12-Kvadrat-Hero Heather 0683
- 13-Limonta- Volpe 111

Moodboard B



- 1-Kvadrat-Mélange Nap 791
- 2-Home Decor- Enea 017
- 3-Kvadrat- Recheck 145
- 4-Limonta-Agamotto 02
- 5-Kvadrat- Recheck 145
- 6-Home Decor- Enea Check 021
- 7-Home Decor- Enea 021

- 8-Limonta-Somme 124
- 9-Kvadrat- Recheck 785
- 10-Kvadrat-Hero Heather 683
- 11-Limonta-Volpe 104
- 12-Kvadrat-Encircle 0762
- 13-Kvadrat-Mélange Nap 771

Moodboard D



- 1-Kvadrat-Mélange Nap 441
- 2-Kvadrat-Hero Heather 0463
- 3-Torri Lana-Ombra 032
- 4-Torri Lana-Rico 270
- 5-Kvadrat- Recheck 115
- 6-Limonta-Alpina 404
- 7-Limonta- Somme 101

- 8-Limonta- Persiano 209
- 9-Kvadrat-Mélange Nap 171
- 10-Torri Lana-Ombra 038
- 11-Kvadrat-Mélange Nap 411
- 12-Kvadrat-Encircle 0452
- 13-Limonta-Agamotto 21

Moodboard E



- | | |
|--------------------------------|-------------------------------|
| 1-Home Decor- Zenith Unito 004 | 8-Kvadrat-Encircle 0652 |
| 2-Kvadrat- Recheck 645 | 9-Kvadrat-Hero Heather 0673 |
| 3-Torri Lana- Rico 240 | 10-Home Decor- Enea Check 010 |
| 4-Limonta-Java 20 | 11-Kvadrat-Mélange Nap 691 |
| 5-Limonta-Volpe 115 | 12-Home Decor- Enea 010 |
| 6-Torri Lana-Contichi 008 | 13-Torri Lana-Contichi 002 |
| 7-Kvadrat-Mélange Nap 651 | |







LOW TABLES



Ø42



Frame in wrought iron /	Top /
Galvanized 5250	Carrara marble  ^A
Grey anthracite 5142	American Walnut  ^A
Grey anthracite 5142	Carrara marble  ^A

90X45 / 120x45



Frame in wrought iron /	Top /
Galvanized 5250	Carrara marble  ^A
Galvanized 5250	American Walnut  ^A
Grey anthracite 5142	Carrara marble  ^A
Grey anthracite 5142	American Walnut

Materials /

Frame in wrought iron /



Galvanized 5250 Grey anthracite 5142

Top in beech plywood /



Carrara marble white American walnut

Low table Ø42

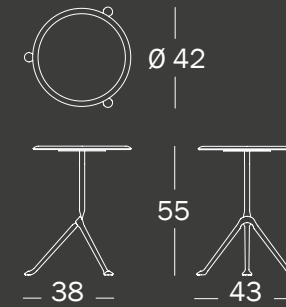

Low table 90x45

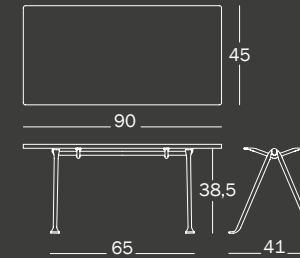

Low table 120x45

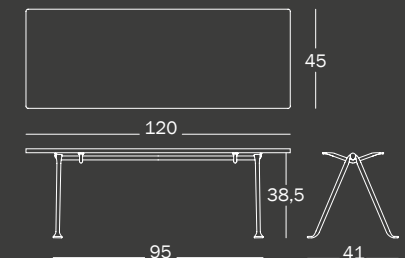

 ^A shows that the product is suitable for outdoor use with regular care and maintenance

PRODUCT CARE

We recommend using a soft rag, either dry or wet. When needed, use ph-balanced soap diluted in water. Do not use abrasive sponges as they may leave scratches. For tops in wood, we recommend using ph-balanced liquid soap especially formulated for wood, diluted in water. For tops in marble, please avoid using acid products. In case of contact of any acid substance with the marble surface, please remove it immediately. We recommend using water and Marseilles soap for marble cleaning. To remove greasy substances and various stains it is possible to use ammoniacs, denatured alcohol, bicarbonate and hydrogen peroxide. If you want to keep the original slate colour, you have to use a treating solution for slate every 3/6 months. If slate is kept inside the use of this treating solution is optional. Before using the treating solution, clean the surface with a damp cloth and if needed, a neutral soap. If persistent stains still remain, clean the tabletop with acetone and allow to dry. To remove scratches caused by a standard use of the top, rub the surface with a damp leather cloth. If slate is seriously scratched, it can be restored as follows: the damaged surface can be wiped with a plastic sponge, softly, to avoid damaging the natural roughness; deep scratches can be rubbed with a piece of rough sand paper first and then with a finer sand paper till the surface become more uniform. Any marks, signs or irregularities that may be visible on the stone tops are peculiarities of the materials and should not be considered as faults. Periodic and correct maintenance allows the product to keep its original aspect and lengthens the duration of its performance.

WARNING

We suggest to protect against bad weather conditions the versions in ash, as they are not recommended for outdoor use unless under cover. Do not use different cleaning products from the ones mentioned above. Do not use the product in an improper way. Do not place hot objects on it, stand on it or use the product as a ladder. Once disused, please make sure that this item is disposed of in an environmentally-friendly way.



OFFICINA BOOKCASE

100X35 / 200X35 / 100X55

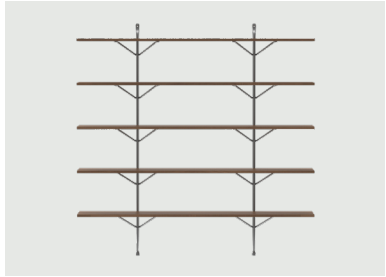

Frame in wrought iron /
Grey anthracite 5142 /
Grey anthracite 5142

Shelves in MDF /
Painted black /
Walnut veneered

Materials /

Frame in wrought iron /



Grey anthracite 5142

Shelves in MDF /



Painted black



walnut veneered

100x35

200x35

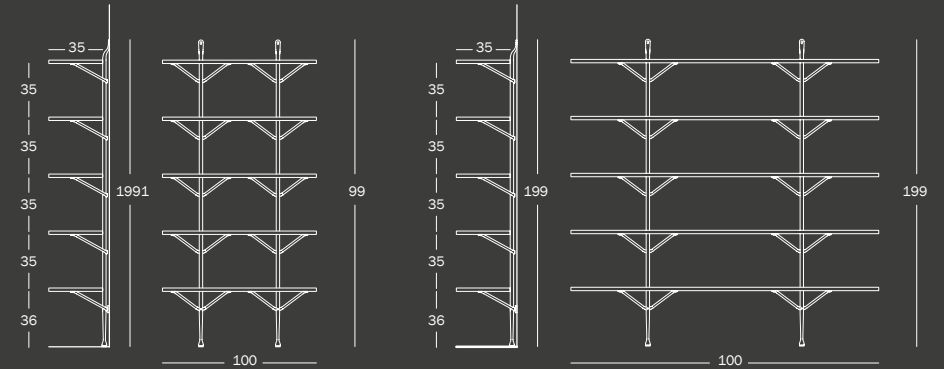

100x55 desk

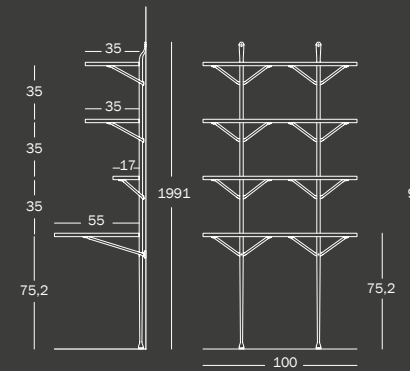

PRODUCT CARE

We recommend using a soft cloth, wet or dry. If necessary, use a mild liquid soap diluted in water, and a mild liquid soap specially formulated for wood diluted in water. Do not use abrasive sponges as they may scratch the product. Avoid the use of acidic products, solvents or products containing ammonia. We recommend cleaning the MDF shelves immediately, as letting stains dry can cause marks, streaks or damage to the surface. Particular care should be taken with highly coloured substances such as coffee, cola, tomato, wine and vinegar etc. Avoid exposure to direct sunlight. Proper regular maintenance will maintain the product's original appearance and prolong its lifespan.

WARNING

DO NOT use cleaning products other than those recommended above. DO NOT use the product in an improper way e.g. climb on it or use it as a ladder. Please make sure this product is correctly disposed of when no longer in use.

! Do not exceed the maximum load of 20 kg per shelf.



ALICE & ACCURAT

MAN RAY
VINTAGE IN ITALIA

Impressionismo

LA STRADA
INTERNI VINTAGE OGGI

Manet

