

Piña

Design Jaime Hayón, 2014

Low table.

Frame in steel rod painted in polyester powder. Top in solid painted ash.

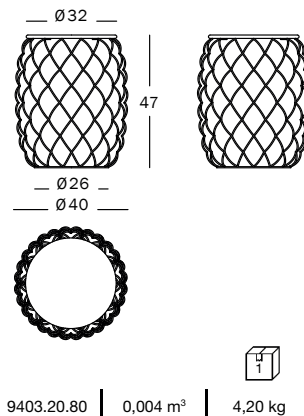

9403.20.80 | 0,004 m³ | 4,20 kg



Art. nr.	Frame in steel	Top in solid ash
TV1990	colours cat.1	colours



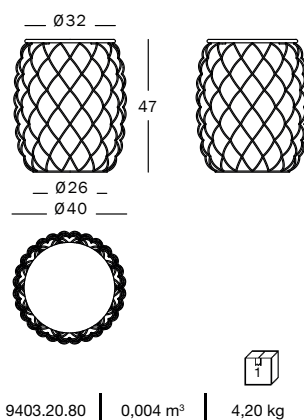







Low table, suitable for outdoor use.

Frame in steel rod, cataphoretically-treated and painted in polyester powder. Top in HPL.



9403.20.80 | 0,004 m³ | 4,20 kg

Art. nr.	Frame in steel	Top in HPL
TV1994	white 5108 (colour cat.2)	white 8500 
TV1995	black 5140 (colour cat.2)	black 8510 

Frame colours cat.1	Top in solid ash	Frame colours cat.2	Top in HPL	Top thickness
 coral red 5084 (*)	 coral red 7070 (*)	 white 5108	 white 8500	solid ash: 12mm
 white 5108	 white 7020	 black 5140	 black 8510	HPL: 12 mm
 black 5140	 black 7065			

Test
 Horizontal fatigue test EN 15372:2008, L3
 Safety requirements EN 15372:2008, L3
 Vertical impact test EN 15372:2008, L3
 Horizontal static load test EN 15372:2008, L3
 Stability EN 15372:2008, L3
 Vertical static load test EN 15372:2008, L3

(*)Note: while stocks last

