

Passe-partout

Design Magis, 2014

Table 47x47 cm, suitable for outdoor use.

Base and column in satined stainless steel.
Top in HPL.

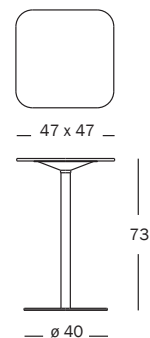



Art. nr.		Base and column in steel	Top in HPL	
TV1800	TV1810	satined stainless	white 8500	
TV1800	TV1812	satined stainless	black 8510	

Table Ø 47 cm, suitable for outdoor use.

Base and column in satined stainless steel.
Top in HPL.





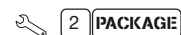
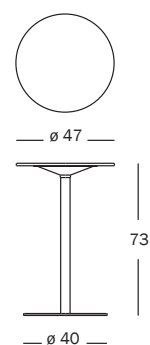

Art. nr.		Base and column in steel	Top in HPL	
TV1800	TV1814	satined stainless	white 8500	
TV1800	TV1816	satined stainless	black 8510	

Table Ø 60 cm, suitable for outdoor use.

Base and column in satined stainless steel.
Top in HPL.

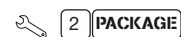
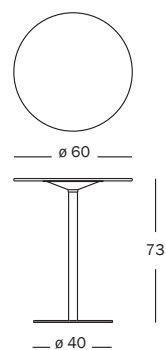

Art. nr.		Base and column in steel	Top in HPL	
TV1800	TV1818	satined stainless	white 8500	
TV1800	TV1820	satined stainless	black 8510	

Base and column in steel

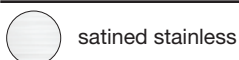

satined stainless

Top in HPL



white 8500

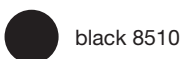

black 8510

Top thickness

HPL: 12 mm

Passe-partout

Design Magis, 2014

Table 70x70 cm, suitable for outdoor use.

Base and column in satined stainless steel.
Top in HPL.

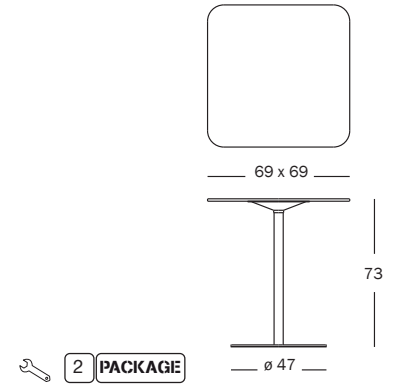



Art. nr.	Base and column in steel	Top in HPL
TV1830 TV1834	satined stainless	white 8500 
TV1830 TV1836	satined stainless	black 8510 

Table Ø 70 cm, suitable for outdoor use.

Base and column in satined stainless steel.
Top in HPL.





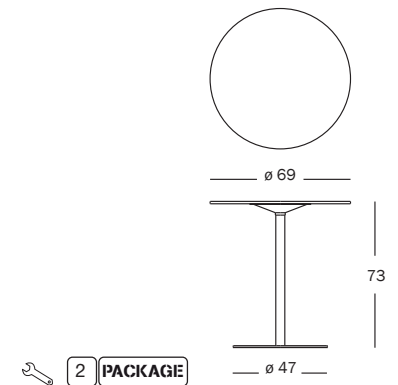

Art. nr.	Base and column in steel	Top in HPL
TV1830 TV1838	satined stainless	white 8500 
TV1830 TV1840	satined stainless	black 8510 

Table alto Ø 60 cm, suitable for outdoor use.

Base and column in satined stainless steel.
Top in HPL.

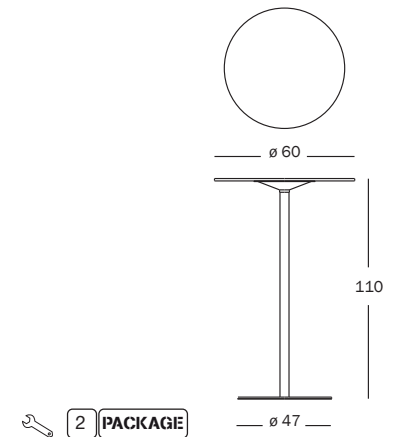

Art. nr.	Base and column in steel	Top in HPL
TV1850 TV1818	satined stainless	white 8500 
TV1850 TV1820	satined stainless	black 8510 

Base and column in steel

 satined stainless

Top in HPL

 white 8500

 black 8510

Top thickness

HPL: 12 mm